

ENJOY BEING FOCUSED

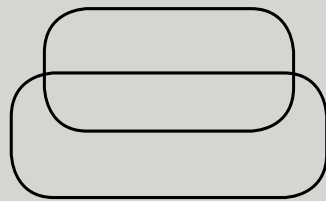

**SOFTREND**

THE SOFA

PUBLIC SPACE COLLECTION **2020**

# Contents

5	Enjoy being focused
6	Multifunctional solutions that can be easily added to improve existing open offices
7	Softrend is an upholstered furniture manufacturer established in 1997
8	Made to last. Sustainably.
10	What should you consider when selecting sound-absorbing furniture?
18	References
22	Public space collection
24	August
32	Hubert
36	Rolf
40	Frankie
46	Lilja
50	Manhattan Hexa
54	Manhattan Penta
60	Meeter
64	Museo
68	Sans
76	Sigmund
78	Sofi

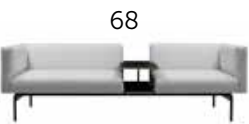
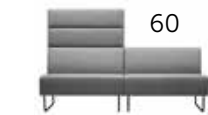
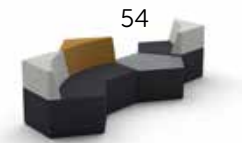
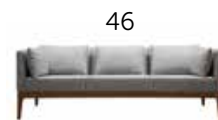



# Enjoy being focused

Open offices were revolutionary – they broke down the barriers between co-workers that cubicles had created. The change gave way to collaboration, communication, and involvement. About 70% of all offices are currently open plan.

But it has its downsides also. **95% of people say they struggle to focus at work.** The most disruptive office distractions are caused by our beloved colleagues – their talking loudly on the phone and chatting nearby. Interrupted work results in 2.1 hours a day lost to office distraction and it takes about 25 minutes to return to the task after a distraction.

The office concept is being redesigned once again. This time the goal is to find **a balance between shared and private space.** To find solutions that provide flexibility and support different ways of working.

As a constantly growing company, we know firsthand what it is like to work in an open-plan office. This is why we dedicate ourselves to providing solutions that make open offices work better.

In a world where you are constantly disrupted at work, Softrend provides **the space where to focus on the most important task at hand.** Our furniture is for people who want to get things done.

# Multifunctional solutions that can be easily added to improve existing open offices

- Different tasks require different working environments. Our solutions are modular, multifunctional and easy to add to existing open-plan offices.
- For making everyone feel comfortable and productive in open-plan offices, it is wise to plan zones for taking a break and chatting with colleagues; more secluded sofas with high walls for individual work; creative corners for meetings and brainstorming sessions; small boxes for phone calls and private conversations.



**CREATIVE & BRAINSTORMING AREAS** – Get ideas flowing in a more relaxed type of meeting room with movable table and high rocking-poufs as chairs.



**LOUNGE AREAS** – Take a moment to chat with colleagues or read a book before diving back into work with a rested mind.



**WORK PRIVATELY** – Focus purely on the task in hand thanks to sound-absorbing walls or make phone calls without disturbing others.

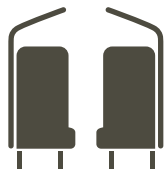

**MEET PRIVATELY** – Make one-to-one meetings more productive with separated sofas with high sound-absorbing walls.

# Softrend is an upholstered furniture manufacturer established in 1997

- Thanks to over 20 years of experience in manufacturing soft furniture, we know how important is good design, comfort, and durability. Our made-to-order public space collection meets the same standards.
- All our products are made by hand in Europe, in our own factory in Estonia. We manage the process from idea to final product, to be sure that everything meets our sustainability and quality standards. We appreciate the benefits of a small company that provide us with flexibility, a personal approach and the ability to react quickly
- We are a family company. Making decisions in the family means considering the long term. This is why our decisions are based on the idea of sustainable development, according to which you need to consider the environment and other people's needs in business and production.
- Great things happen through collaboration. We work together with different designers to offer innovative products to contemporary offices and public spaces.



# Made to last. Sustainably.

We are making a conscious effort to be able to proudly call ourselves a waste-free company

- We believe all materials should be used sustainably – our product range includes Green label collection – sofas, pillows, and poufs made of leftover materials as well as an upcycling product range created in cooperation with renowned designer Reet Aus.
- Our contract fabric collection includes cover materials that are made from recycled plastic bottles.
- We organised a drawing competition for children to design soft toy animals together with MiaPuPe. These toys are made by seamsters with hearing impairments using leftover materials from Softrend's factory. Part of the profits from each toy is donated to students with hearing impairments.
- Everything we make and deliver to our private customers is packaged using recyclable material.
- Softrend is making an effort to become a waste-free company and is looking for new ways and new technologies to use all sorts of excess material without creating more waste. For example, we use a special cutting machine to minimise waste when cutting fabric.



## Our quality standard



### FUNCTIONALITY

**Durable, high-quality materials:** 5-year guarantee on solid wood frames

**High-quality fabrics:** a carefully selected collection

**Comprehensive and continuous product development:** every product has its own story

**The right sofa for you:** we prepare it according to your exact requirements so that you will be satisfied with your sofa for a long time



### DESIGN

**Wide selection:** different models, dimensions and upholstery options

**More than just a sofa:** many compatible products

**Softrend's style:** timelessness and calm in a Nordic way

**A sofa that looks good should also be comfortable:** we collaborate with leading designers



### SERVICE

**20 years of experience:** we understand you and can recommend furniture that is perfect for your lifestyle and needs

**Follow-up service:** our team will be happy to take care of Softrend products, even if they are already yours

**Design-conscious consultants:** all our employees are fans of Softrend's products



# What should you consider when selecting sound-absorbing furniture?

When walls vanish and an office opens up, you develop a need for places that can be described as rooms within rooms. Such places can be created using removable screens and furniture that absorbs sound, thereby allowing you to have a more private conversation or a place to contemplate things in peace. Our acoustic environment plays a major role in our lives. It affects our working efficiency and ultimately also our health.





# Sound perception

Public space and open offices often have problems with resonance, meaning that sounds reverberate for too long. Creating a more pleasant environment requires us to dampen all kinds of different sounds, such as fans, people's footsteps, conversations and phone calls.

People's perception of sound depends on a variety of factors, including level and frequency, but also the type of the sound: whether it is constant or fragmented, noise or music.

The ear is highly sensitive and sound waves don't have to be particularly strong to be heard. People hear sounds from 0 dB to 120 dB (the pain threshold) at the frequency range of 20-20000 Hz. Sounds that are at a lower frequency than the limit of human hearing are called infrasound, while sounds exceeding that limit are called ultrasound. For voice and speech recognition, the most important frequency range is 300-3000 Hz.

People perceive sound differently. Something barely audible to one person may disturb another. Even one person can perceive the same sound differently depending on the situation. A 10 dB increase in the level of sound is considered to double the loudness of the sound. A change of 1-2 dB is considered to be the smallest alteration that humans can perceive.

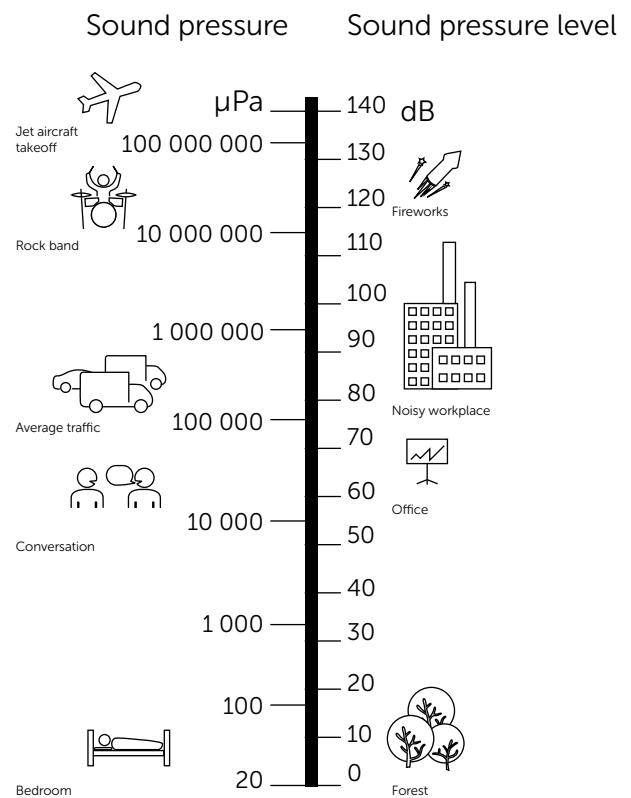

# Acoustic absorption

Sound waves cannot move freely in a closed room and bounce off the structure of the room. Some of the sound is absorbed by surfaces, while some reflects from them. Monitoring sound absorption and achieving the recommended reverberation duration is one of the principal tasks in the acoustic design of rooms.

Acoustic absorption means that sound does not reflect off a material after reaching it. That is also the principle of designing furniture with acoustic properties: furniture has to absorb the sound that would otherwise reflect back and contribute to unwelcome noise. Materials with good sound absorption are porous and breathable. Synthetic felt and a range of foams are among the materials with such properties, which we also use in Softrend products. The models in the August and Sigmund ranges also use felt fabrics for upholstery to ensure better sound absorption. The calculated sound absorption for the models in the August range is between 0.2-5.1 sabins\*, depending on the sound absorption coefficient of the particular material.

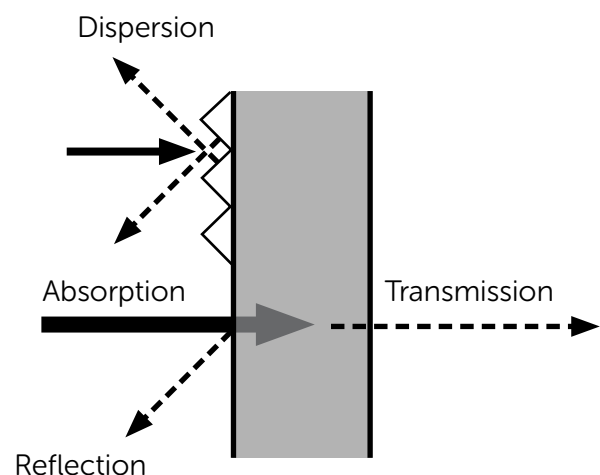

**The decibel** is used in acoustics to express the level of sound pressure (symbol L) relative to 0 dB. The agreed sound pressure for this 0-level is 20 micropascals ( $\mu\text{Pa}$ ), which corresponds to the threshold of human hearing.

**Sound pressure or acoustic pressure** is a change in the ambient atmospheric pressure in the form of a wave. As it moves through the air, sound creates areas of high and low airtightness. As sound moves through the air its pressure also alters somewhat. Small changes in air pressure caused by sound moving through the air are referred to as sound pressure. The unit used to describe acoustic pressure is the pascal (Pa). The human ear reacts to sound pressure, which is what causes us to hear sounds.

**The threshold of hearing** is the minimum sound level or pressure that human beings can perceive as audible sound. The threshold of hearing at 1000 Hz is deemed to be equal to 10-12  $\text{W}/\text{m}^2$  ( $2 \cdot 10^{-5}$  Pa). This sound pressure value is used as a base or comparison level (0 dB) on a scale of the relative sound pressure level (usually a logarithmic scale in decibels) when describing findings in hearing studies.

The acoustic absorption of materials is characterised by the **acoustic absorption coefficient**, which does not have a unit and can vary from 0 (fully reflective) to 1 (fully absorbent). The acoustic absorption of furniture can be described by its equivalent absorption area, which is equal to the absorption coefficient multiplied by the surface area of the material ( $\text{m}^2\text{sabin}$ ). This size is used when calculating the reverberation duration of a space.

# Recommendations for pleasant working environments

## Office space

To achieve a good acoustic environment in offices, we recommend that the space be designed to ensure a reverberation duration of around 0.6 seconds at 250-4000 Hz. It is important to consider the number of employees, the noise created by office equipment and the need to have private conversations and phone calls. Sound-absorbent surfaces should be in close proximity to office equipment. The more people there are in the space, the greater the need for surfaces with acoustic absorption properties.

Suitable products: Sigmund, August, August Wall, Frankie

## Meeting rooms

Solutions for meeting rooms should take into account the size of the rooms. For smaller meeting rooms, the reverberation duration at 250-4000 Hz should be 0.6 seconds, but it is better to aim for 0.8 seconds in more spacious rooms. Voices should be clear and understandable in all parts of the room, meaning that surfaces with semi-reflective properties can help achieve a good acoustic environment in larger rooms.

Suitable products: August Wall or Sigmund sound-absorbing panels

## Open-plan offices

The optimal reverberation duration that you should aim for when designing the space should be 0.5 seconds at 250-4000 Hz. It is advisable to use sound-absorbing screens to separate workplaces and avoid noise-reflective surfaces.

Suitable products: Sigmund, August, August Wall, Frankie

## Other public space

Similar principles to those of open-plan offices apply in restaurants, hospitals, museums, hotel lounges, shopping centres and other public areas. Such places are bustling with people, and there are all kinds of sounds coming in at different frequencies, which often leads to a lot of reverberation.

Sound-absorbing furniture and panels should be positioned as close as possible to the sound source and should also be present in places where the sound energy is initially reflected back by desks and paths of movement. Soft surfaces close to the workplace absorb most of the sound, significantly improving the acoustic environment.



For voice and speech recognition, the most important frequency range is 300-3000 Hz.

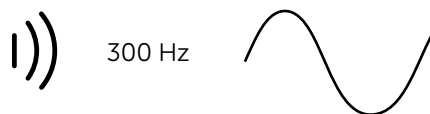
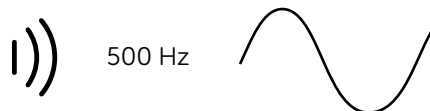
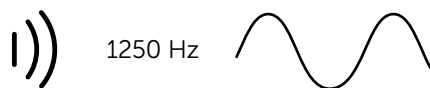
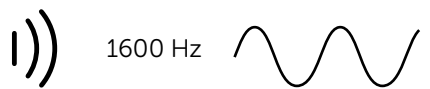
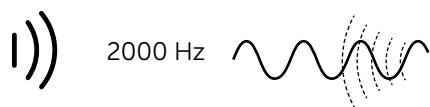
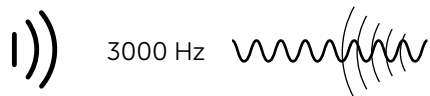

# Calculated sound absorption values



2-S/ H1

Equivalent absorption area per object (m<sup>2</sup>Sab / object)

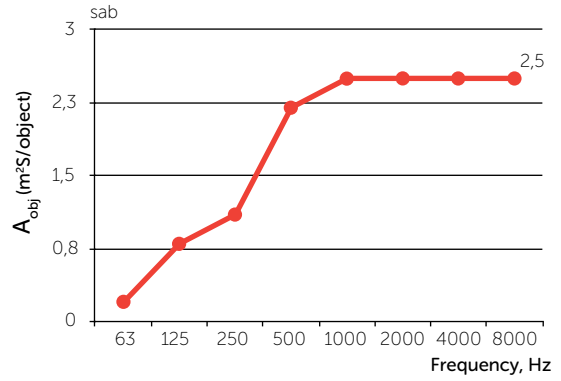

2-S/ H2

Equivalent absorption area per object (m<sup>2</sup>Sab / object)

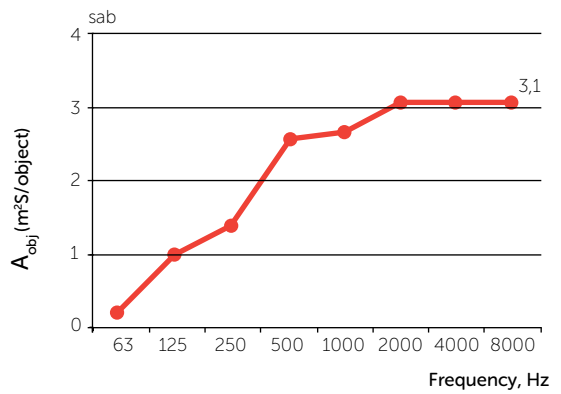

2-S/ H3

Equivalent absorption area per object (m<sup>2</sup>Sab / object)

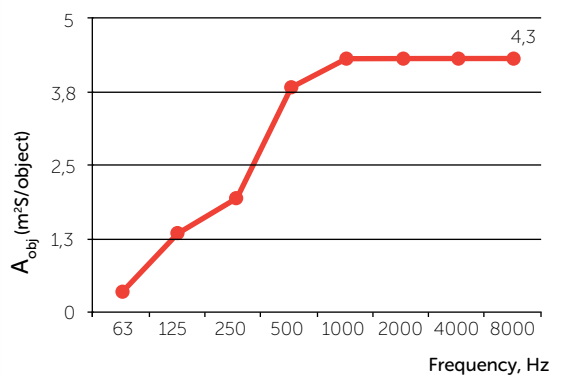

Equivalent absorption area per object (m<sup>2</sup>Sab / object)

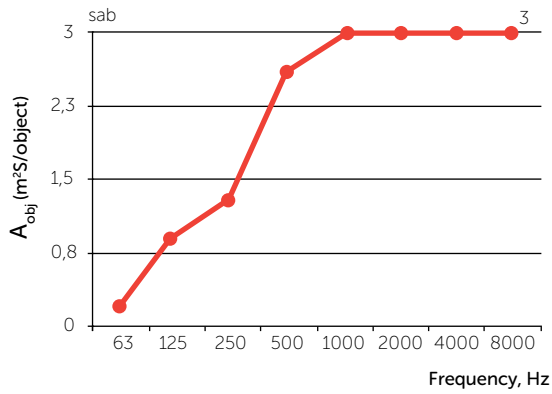

2,5-S/ H1

Equivalent absorption area per object (m<sup>2</sup>Sab / object)

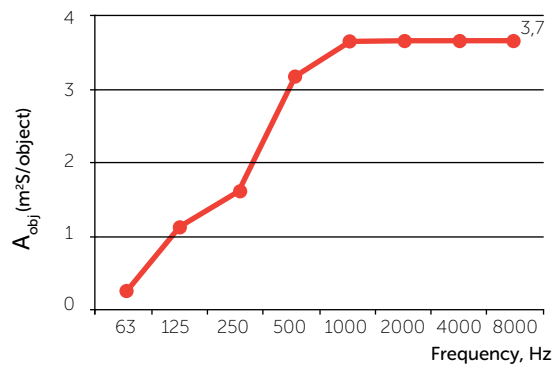

2,5-S/ H2

Equivalent absorption area per object (m<sup>2</sup>Sab / object)

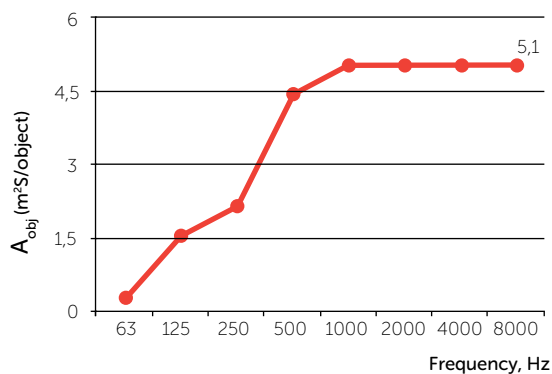

2,5-S/ H3

Calculated acoustic absorption values of August product range developed in cooperation with experts from Akukon



# References



Apollo Cinema,  
Tallinn, Estonia



Toyota Baltics  
Office,  
Tallinn, Estonia



AGA Office,  
Tallinn, Estonia



Tallinn Airport  
Lounge, Estonia

Aalborg University  
Lounge, Denmark



DAS Business  
Furniture Showroom,  
London, England



Public high-school  
in Tallinn, Estonia



Private office,  
Finland





Nortal office,  
Tallinn, Estonia



Private company,  
London, England



Pipedrive offices,  
Tallinn, Estonia



Elisa office,  
Tallinn, Estonia



Nortal office,  
Tallinn, Estonia

# Public space collection





# August

Sound-absorbing sofa



This product has been created for:

- › Concentration and seclusion
- › Private meetings
- › Dividing space into different zones
- › Improving the acoustic properties of the room



**Design: Pent Talvet**  
Iseasi

The **August** series of sofas with sound-absorbing qualities was created especially for open-plan working environments. The sofas come in a range of widths and heights, allowing you to create free-standing islands of privacy of different shapes and sizes where you can hold mini-meetings, delve into paperwork or make important phone calls away from busier working areas. In terms of style, the August is chic in a slightly reserved way and very composed. The asymmetrical backrest pillows, which resemble sea stones, provide a friendly accent. The functional nature of the August has been packaged in a compact, modest form that's designed to fit in with any interior. High-quality materials and skilled craftsmanship ensure that you can rely on the August to live up to the needs of your office for a long time.



## Product information

### Frame

Solid wood and plywood

### Seat & backrest

Durable and fireproof HR-foam;  
fixed seat and back cushions

### Legs

1. Solid oak (metal & timber frame); finishing options that can be ordered separately at customer's request: solid ash, stained and varnished
2. Powder-coated metal legs; anti-slip soles
3. 360° rotating leg, powder-coated metal; for model 1-S



### Plug-in option

### Additional information

The cover fabric is not removable; **sides and rear wall of H3 models: only felt cover fabric**

### Accessories

#### Additional table T1

Material: innovative Valchromat mdf, high-pressure laminate; frame: powder-coated metal

#### Additional table T2

Material: innovative Valchromat mdf, high-pressure laminate; frame: powder-coated metal

Table can be moved

#### Workbay wall fastenings

Material: powder-coated metal







1-S/ H1



1-S/ H2



1-S/ H3



2-S/ H1



2-S/ H2



2-S/ H3



2,5-S/ H1



2,5-S/ H2



2,5-S/ H3



2-S/ H2



2,5-S/ H3



2,5-S/ H3

# August Workbay

The August sofa set provides an easy solution for creating a workbay where you can go to get some privacy or have meetings. The only thing it takes is to connect two roofed Augusts with a partition wall. August's bent roof and high-rise sides add some excitement to the interior as well as providing a large, sound-absorbing surface. This is what makes the August Workbay perfect for holding meetings and having private conversations.



# August Wall

Soft wall panels with a separate pouf add a playful touch to the August range. Sound-absorbing panels help improve the acoustic properties of open rooms.

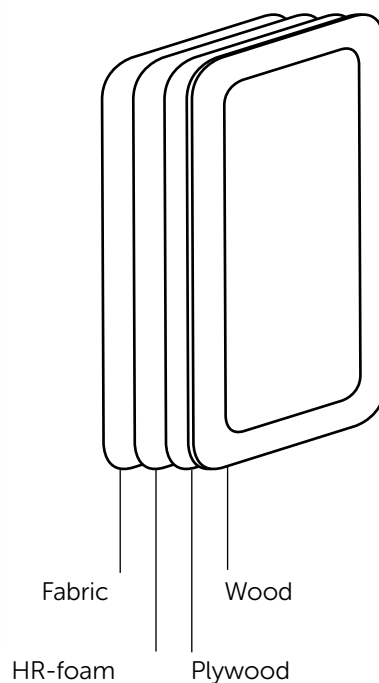

There is an air gap between the panel and the wall which functions just like a sound-absorbent material in dampening low-frequency sounds. Panels need to be fixed to the wall.

# Dimensions

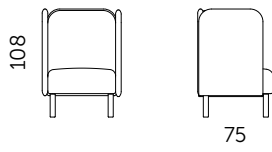

**1-S/ H1**

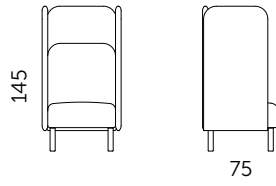

**1-S/ H2**

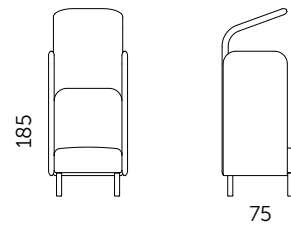

**1-S/ H3**

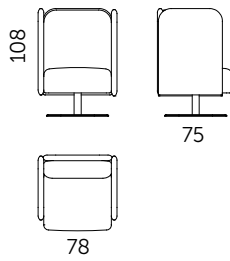

**1-S/ H1/ L3**

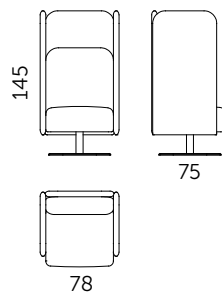

**1-S/ H2/ L3**

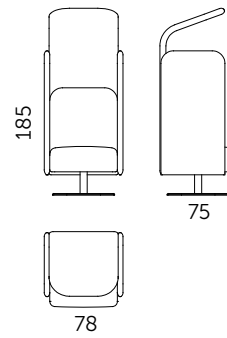

**1-S/ H3/ L3**

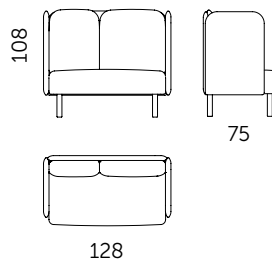

**2-S/ H1**

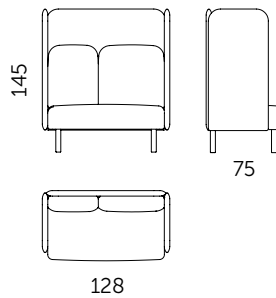

**2-S/ H2**

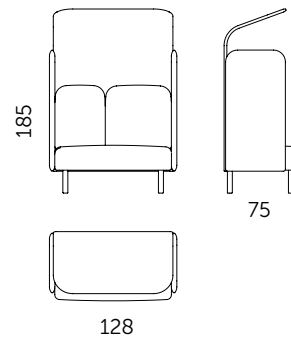

**2-S/ H3**

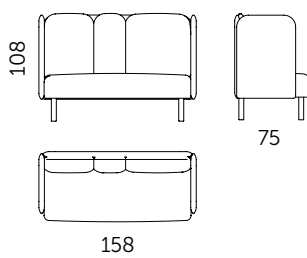

**2,5-S/ H1**

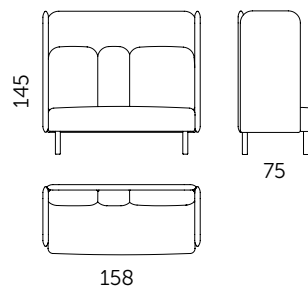

**2,5-S/ H2**

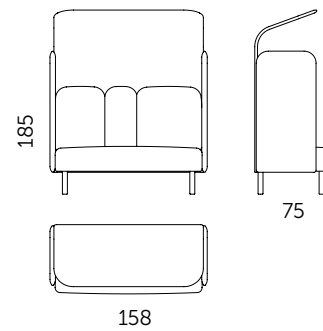

**2,5-S/ H3**

All dimensions provided in centimetres.

Seat depth: 48 cm

# Dimensions

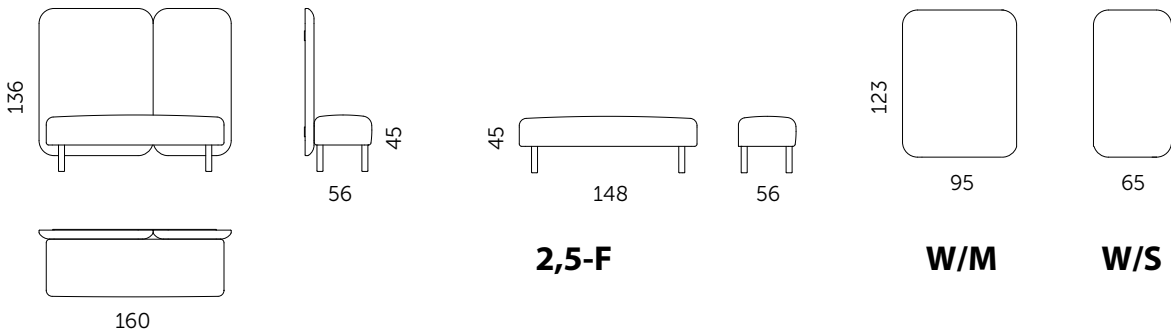

**2,5-F + W/M + W/S**

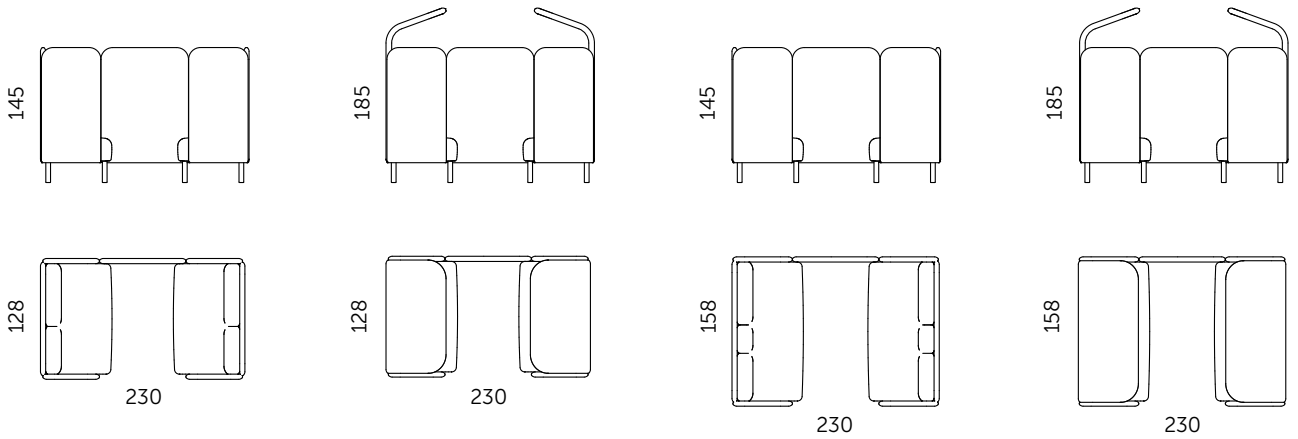

**2-S/ H2 Workbay**

**2-S/ H3 Workbay**

**2,5-S/ H2 Workbay**

**2,5-S/ H3 Workbay**

Choose Workbay wall options:

Seat depth: 48 cm

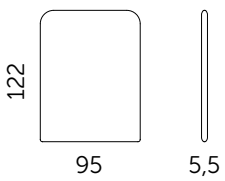

**W-93**

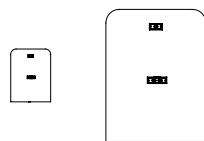

**W-93/E**

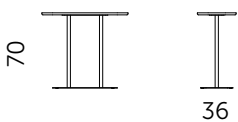
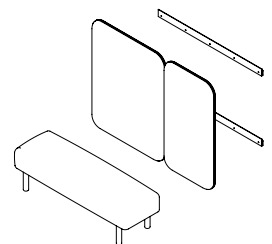

**T-1**

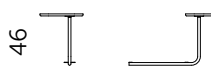

**T-2**

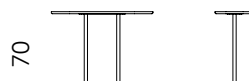

**T-3**

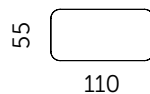
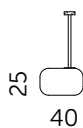

All dimensions provided in centimetres.

# Hubert

High pouf



This product has been created for:

- > For active co-creation
- > For brainstorming
- > For teamwork



Design: Martin Pärn & Janno Nõu, Iseasi

**Creative Corners** brings co-creation space into the office. There's a time and a place for every kind of work. Including creating and working in teams. We need dynamic and flexible space where furniture doesn't hamper us, but instead empowers our collective creativity – without us even being aware of it – to think up something new, to develop and test our ideas, to play with our plans. Innovative environments that support working together ask for different type of settings and furniture than we're used to seeing in an office. The Creative Corners range brings new ideas and new kinds of behaviour into your office, and gets them working for you.

The best way of getting a team to push new ideas forward is to keep them, quite literally, on their toes. With everyone standing, all ideas and thoughts are equal, spontaneous and welcome. And if we use walls, we create an active and information-rich space that supports the generation of ideas and the development of projects. Furniture should support such active use of space.

You can work at the table on your feet or by resting your weight on one of our **Hubert** poufs. Chairs with raised seating keep your back straight and your mind sharp. They set you no barriers. Jumping up to throw yourself into the discussion is quick and easy. You can sit on them facing any direction you like. A rocking version will bring versatility to your everyday work and add a sense of dynamism to the space you're in.



## Product information

### Frame

Solid wood and plywood

### Upholstery

Durable and fireproof HR foam

### Legs

Rocking base; material: oak

360° rocking base; material: plastic POM, black

### Additional information

The cover fabric is not removable

Take a look at other products that go with Hubert: the Rolf mobile table.





# Dimensions

## Rocking base

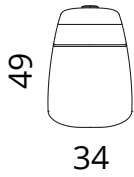
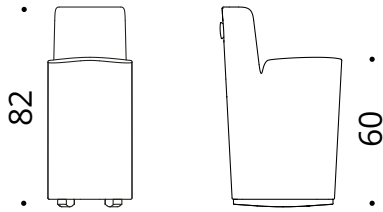

**L1**

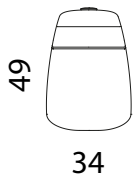
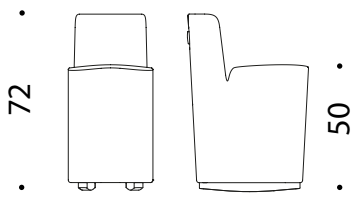

**Mini L1**

## 360° rocking & rotating base

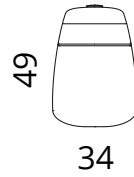
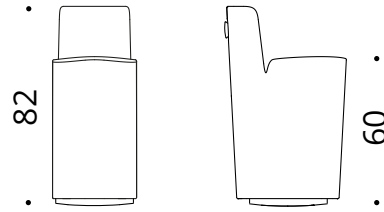

**L2**

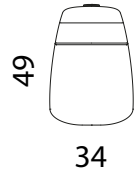
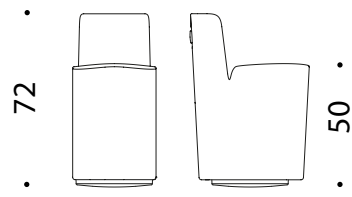

**Mini L2**

Seat depth: 36 cm

All dimensions provided in centimetres.

# Rolf

The mobile table



This product has been created for:

- > Brainstorming
- > Teamwork
- > Co-creation



Designed for cooperation, the mobile **Rolf** table can be easily moved around in your space. Given its height, it's perfect for creating and discussing plans and getting everyone involved in co-creation. You can work at the table on your feet or by resting your weight on one of our **Hubert** poufs.

Design: Martin Pärn & Janno Nõu,  
Iseasi



## Product information

### Tabletop

Matte, high-pressure laminate Formica Infiniti™: black, white; oak edging

### Legs

Varnished oak; wheels



# Dimensions

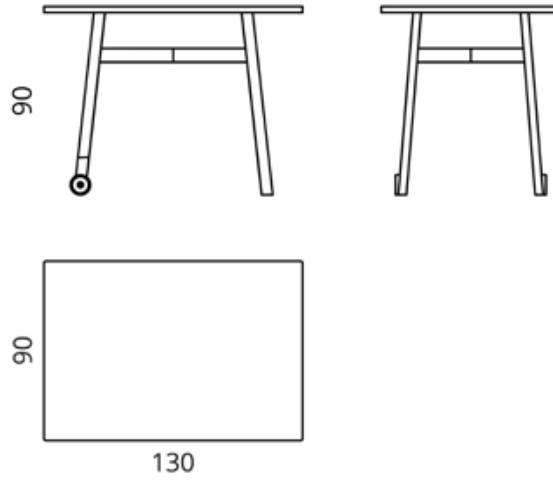

**ROLF-130**

All dimensions provided in centimetres.

# Frankie

Work sofa



This product has been created for:

- › Concentration and seclusion
- › Private meetings
- › Dividing space into different zones
- › Resting or relaxation
- › Finding inspiration



Design: Argo Tamm

Slender but with soft corners, Frankie is characterised by being **comfortably multifaceted** – different sizes and walls which you yourself choose to combine narrower and more enclosed or conversely larger workspace sofas. The set also includes moving tables: a smaller one with space for a computer, mug or magazine and a larger one in which there are power sockets for charging devices. Frankie offers a wide range of playful choices and is perfect for creating workspaces with a new sort of functionality and evolving needs.



## Product information

### Frame

Metal, solid wood and plywood

### Upholstery

Seats have high-elastic durable HR foam rubber with FR certification

### Small extra pillow

Feather filling

### Legs

Powder-coated metal; anti-slip soles



### Plug-in option

### Additional information

Wide range of cover materials, including flame-retardant textiles

### Accessories

#### Additional table T-330

Material: innovative Valchromat mdf, high-pressure laminate; frame: powder-coated metal  
Table is movable





2S+2WL+2WR



2S+3WL+3WR



2S+3WL+2WR



2S/2WR+2WR



1S+2WL



1S+3WL

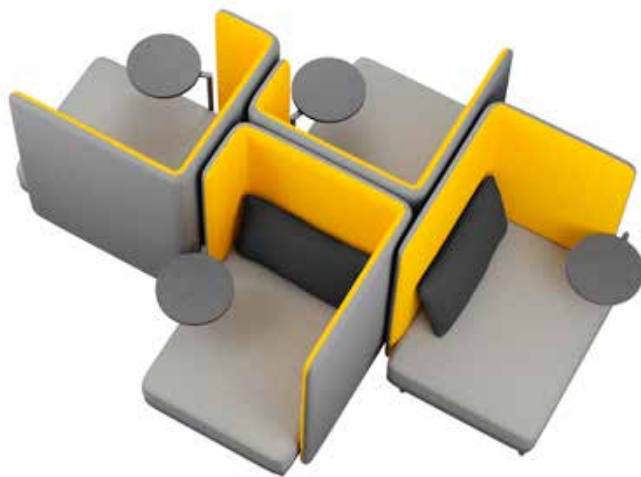



# Dimensions

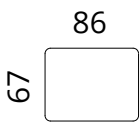
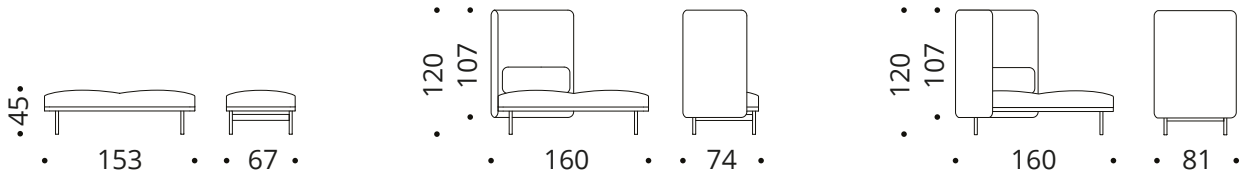

**1-F**

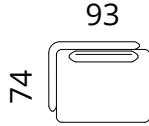

**1S+2WL**

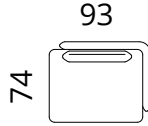

**1S+2WR**

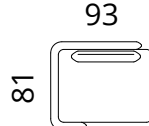

**1S+3WL**

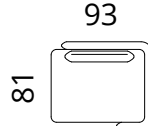

**1S+3WR**

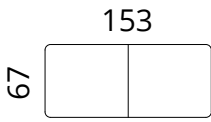

**2-F**

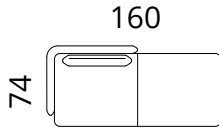

**2S+2WL**

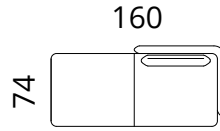

**2S+2WR**

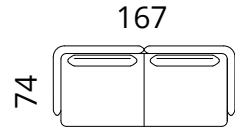

**2S+2WL+2WR**

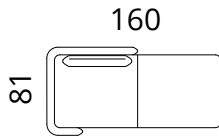

**2S+3WL**

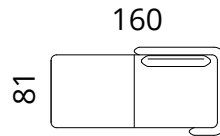

**2S+3WR**

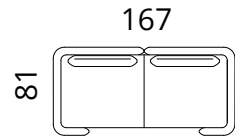

**2S+3WL+3WR**

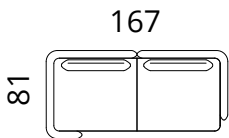

**2S+3WL+2WR**

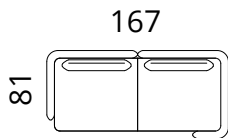

**2S+2WL+3WR**

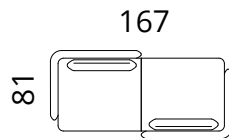

**2S+2WL/2WR**

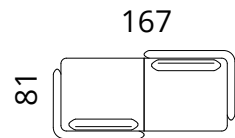

**2S/2WL+2WR**

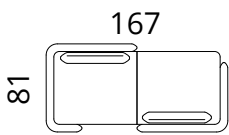

**2S+3WL/2WR**

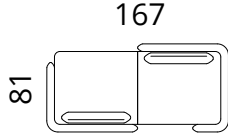

**2S/2WL+3WR**

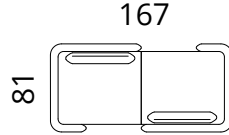

**2S+3WL/3WR**

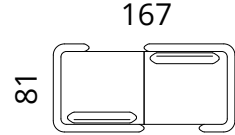

**2S/3WL+3WR**



**T-330**

All dimensions provided in centimetres.

# Lilja

Modular sofa



This product has been created for:

- › Public areas
- › Waiting areas
- › Lounges
- › Open-plan office islands



The Lilja was designed in cooperation with Finnish designer Samuli Naamanka. Its harmony and timelessness make it a true pearl for public space. Warm and friendly solid wood and elegant lines make up a pleasing piece of furniture that reflects the Nordic attitude to style and quality. One of the most important qualities of the Lilja is that it is modular. You can play around and create versatile combinations for rooms with different functions, as well as making the sofa even more personal by selecting the colours and armrests your prefer. The warmth and ergonomic design of this sofa plead with you to take a seat. It is truly comfortable.

Design: Samuli Naamanka



## Product information

### Frame

Solid wood and plywood

### Upholstery

Durable and fireproof HR-foam

### Small extra pillow

Backseat pillow: available with feather filling or fibre filling

Armrest pillow: available with feather filling or fibre filling



### Plug-in option

### Leg frame

Solid wood oak, ash; finishing options on special order: solid wood ash, stained and varnished

### Modular design

Modules can be connected together

### Additional information

The cover fabric is not removable; wide range of cover materials, including flame-retardant textiles

# Dimensions

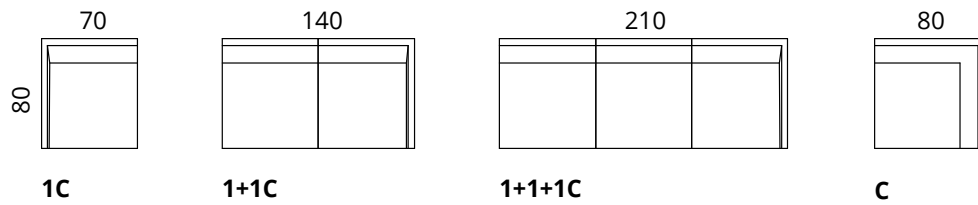
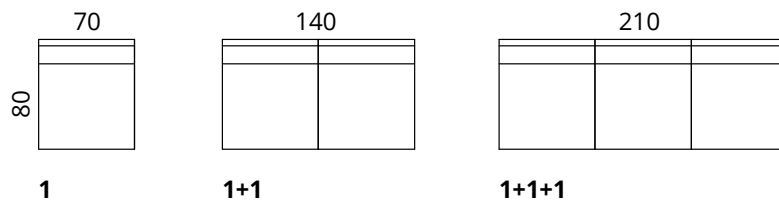
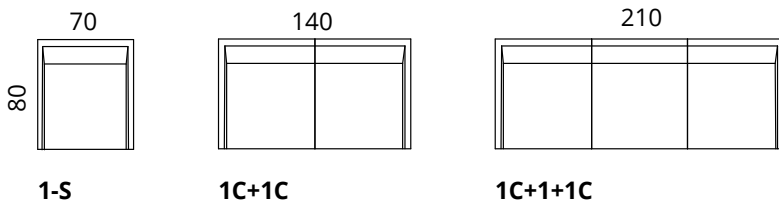
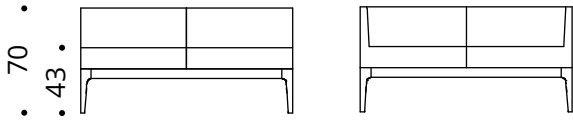

## Leg frames

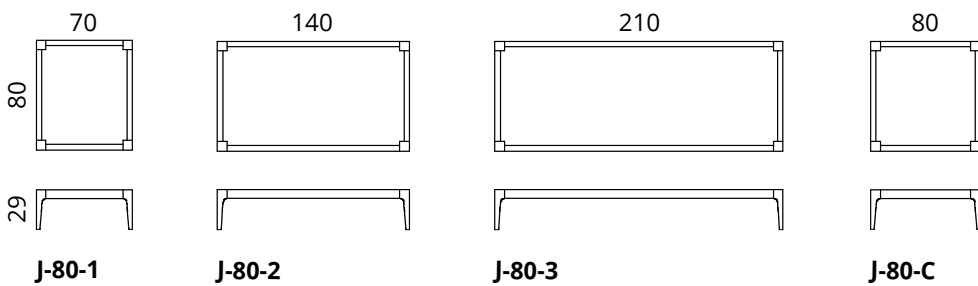

All dimensions provided in centimetres.

Seat depth: with small extra pillow 48 cm; without small extra pillow 61 cm

# Example combinations

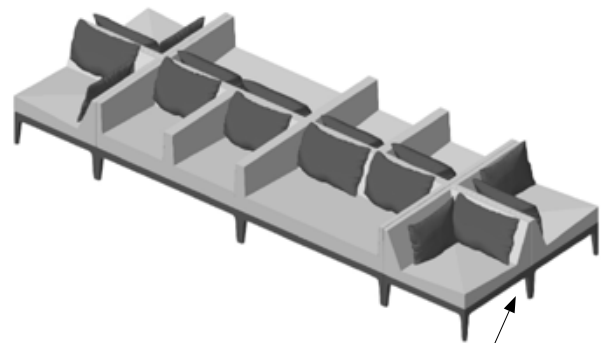
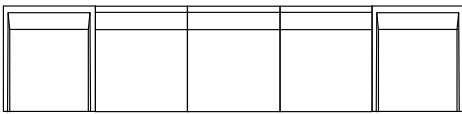
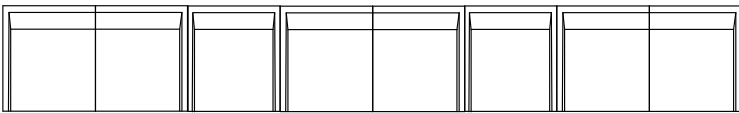
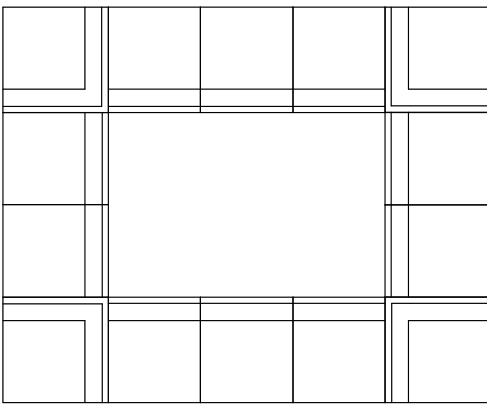
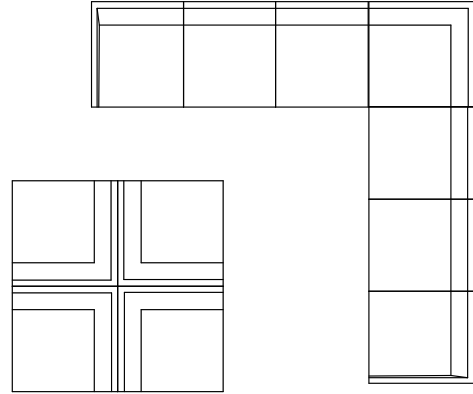
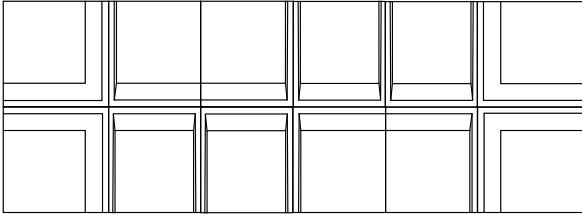

Modules can be connected together





# Manhattan Hexa

Multifunctional hexagonal seating system



This product has been created for:

- › Public, corporate, educational and hospitality environments
- › Teamwork islands
- › Dividing space into different zones
- › Informal meetings



Design:  
Morten Nikolajsen

The Manhattan Hexa multifunctional hexagonal seating system can be arranged in endless inspiring combinations, each one slightly different from another. It fits perfectly in both playful, flowing rooms and spaces that call for a touch of whimsy and softness. Manhattan Hexa is customisable for all public spaces from schools and waiting areas to cosy offices.

The designer's guiding principle is to "make long-lasting products and leave the world in better shape than the how we found it" – an important thought to further develop on your own or together with your team or community.



## Product information

### Frame

Solid wood and plywood

### Upholstery

Seats and backrest have durable and fireproof HR foam

### Legs

Adjustable legs with plastic covers



Plug-in option

### Modularity

Modules can be connected together

### Additional Information

The cover fabric is not removable; wide range of cover materials, including flame-retardant textiles



# Dimensions

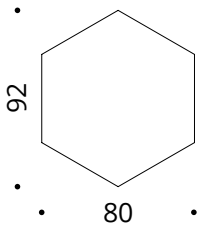
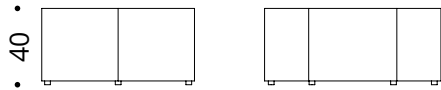

**1-F**

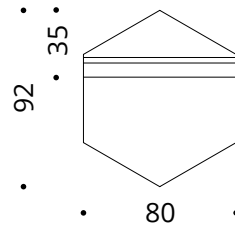
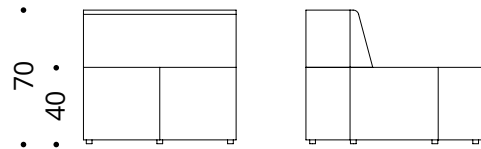

**1-S**

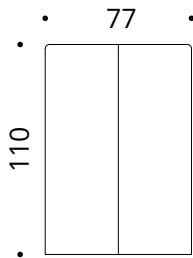

**W/ H1**

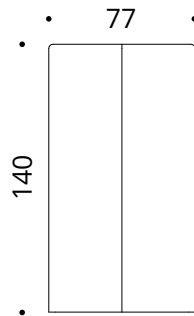

**W/ H2**

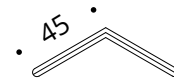
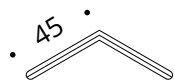

Seat depth: 57 cm

All dimensions provided in centimetres.

# Manhattan Penta

Multifunctional pentagonal seating system



This product has been created for:

- › Public, corporate, educational and hospitality environments
- › Teamwork islands
- › Dividing space into different zones
- › Informal meetings



Design:  
Morten Nikolajsen

The Manhattan Penta multifunctional pentagonal seating system can be arranged in endless inspiring combinations, each one slightly different from another. It fits perfectly in both playful, flowing rooms and spaces that call for a touch of whimsy and softness. Manhattan Penta is customisable for all public spaces from schools and waiting areas to cosy offices.

The designer's guiding principle is to "make long-lasting products and leave the world in better shape than the how we found it" – an important thought to further develop on your own or together with your team or community.



## Product information

### Frame

Solid wood and plywood

### Upholstery

Seats and backrest have durable and fireproof HR foam

### Legs

Adjustable legs with plastic covers; metal socket option

### Modularity

Modules can be connected together



### Plug-in option

### Additional Information

The cover fabric is not removable; wide range of cover materials, including flame-retardant textiles

### Tabletop

Matte, fingerprint-resistant, high-pressure laminate Formica Infiniti™; colour options: black, white







# Dimensions

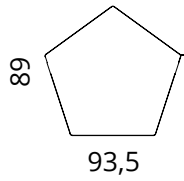
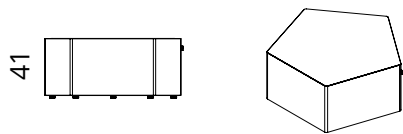

**1-F**

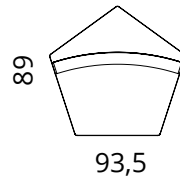
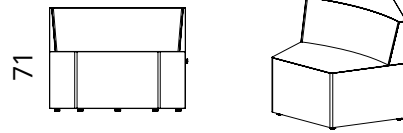

**1-S/ H1**

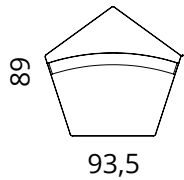
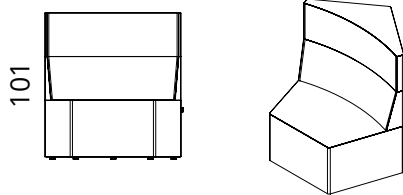

**1-S/ H2**

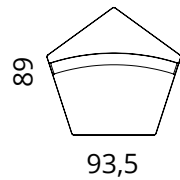
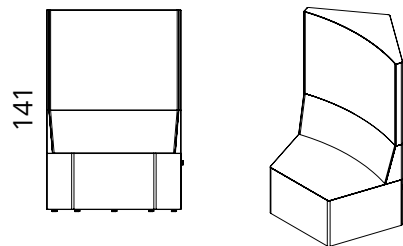

**1-S/ H3**

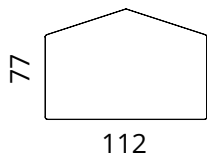
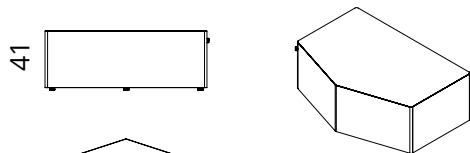

**1-F/ST**

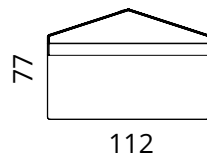
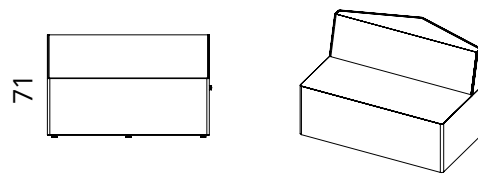

**1-S/ST**

All dimensions provided in centimetres.

Seat depth: 50 cm (modules 1-S/ST and 1-F/ST: 44 cm)

# Dimensions

## Tables

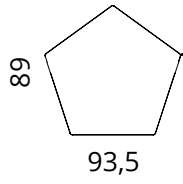
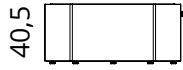

**T2**

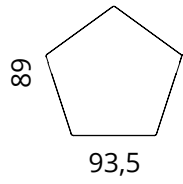
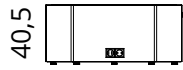

**T2/E**

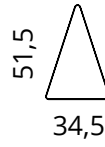
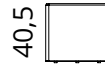

**T1**

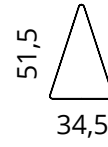

**T1/E**

## Accessories

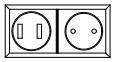

**E**

## Sockets

Min. order 10 pcs.

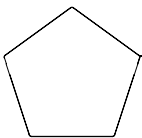

**SOC**

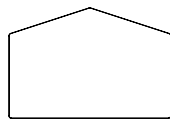

**SOC/ST**



**SOC/T1**

Socket height 6 cm.

All dimensions provided in centimetres.

# Meeter

Sofa



This product has been created for:

- > Cafés and restaurants
- > Waiting areas
- > Tight conditions
- > Private conversations



Design: Argo Tamm

Meeter is a **modular sofa for all kinds of public space**: restaurants, waiting areas, offices and more. It can be put together from modules of three different heights whose width is your choice: anywhere between 62-150 cm. Adding a touch of character is the sofa's slender metal legs. Meeter solutions are ideal for team and individual work. They can be formed into combinations for group work or used to divide up your space into separate units. The filling and covering materials are durable and fireproof, as public space demands.



## Product information

### Frame

Solid wood and plywood

### Upholstery

Seats and backrest have durable and fireproof HR foam; seat cushions and backrest pillows are fixed

### Legs

Powder-coated metal: matte black RAL 9005; anti-slip soles

Socket option, wooden legs

### Modularity

Modules can be connected together

### Additional Information

The cover fabric is not removable; wide range of cover materials, including flame-retardant textiles



Standard lengths 62, 80, 100, 120, 150  
 Custom lengths available

# Dimensions

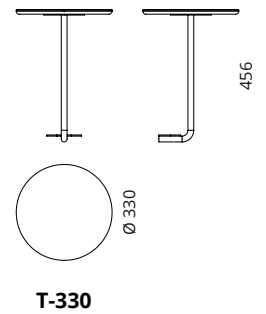
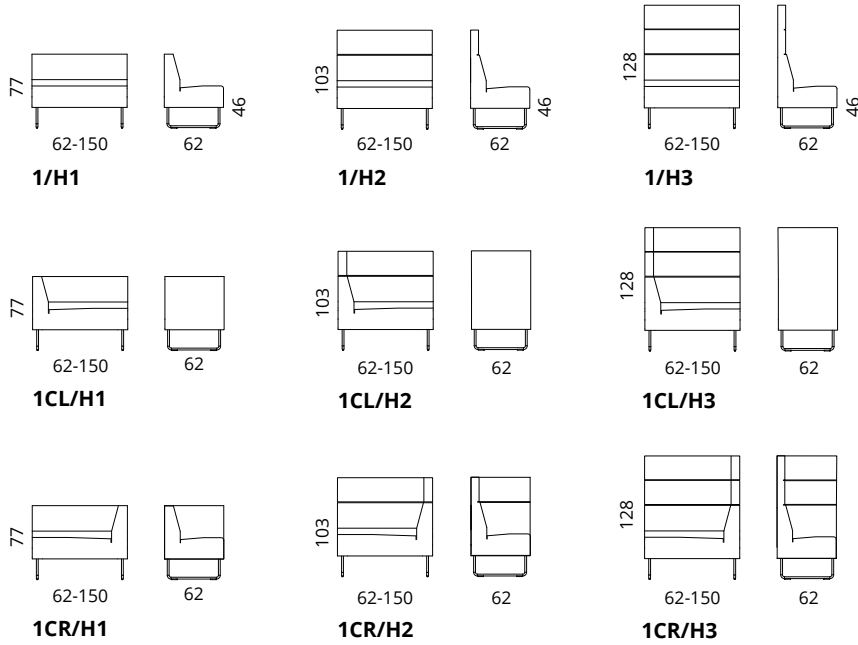

## Meeter with socket

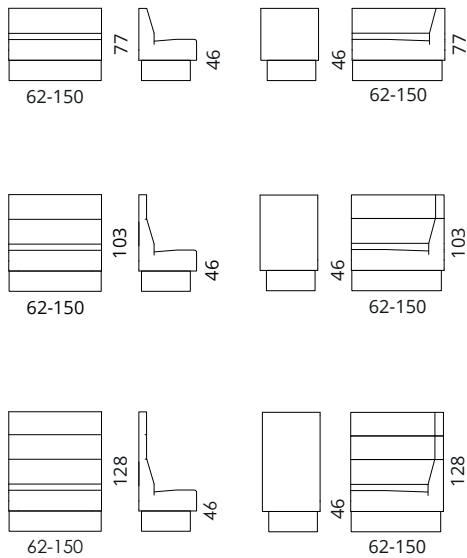

## Meeter Sofa

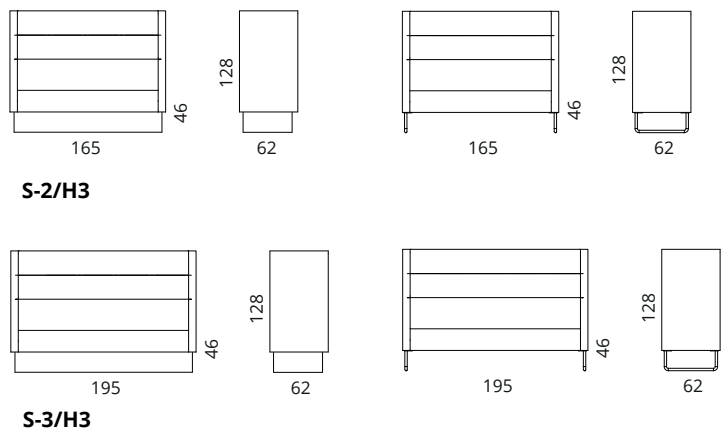

Seat depth: 45 cm

All dimensions provided in centimetres.

# Museo

Modular sofa



This product has been created for:

- › Cafés and restaurants
- › Public areas
- › Waiting areas
- › Open-plan office islands



Design: Argo Tamm

The keywords with this sofa are comfort, flexibility and mobility. It comprises modules from which you can create a variety of combinations. Museo is universal and classic in form, making it perfect for waiting areas in just about any public space. Adding a touch of lightness and character are its metal legs, which come in a range of finishes. The filling and covering materials are durable and fireproof, as public space demands.



## Product information

### Frame

Solid wood and plywood

### Upholstery

Seats and backrest have durable and fireproof HR foam; seat cushions and backrest pillows are fixed

### Legs

Powder-coated metal: black matte RAL 9005; anti-slip soles

### Modularity

Modules can be connected together

### Additional Information

The cover fabric is not removable; wide range of cover materials, including flame-retardant textiles



### Plug-in option

### Accessories

#### Small table

Material: innovative Valchromat mdf, high-pressure laminate, plug-in option

#### Large table

Material: innovative Valchromat mdf, high-pressure laminate, plug-in option

Armrest 1: KT1

Armrest 2: KT2



# Dimensions

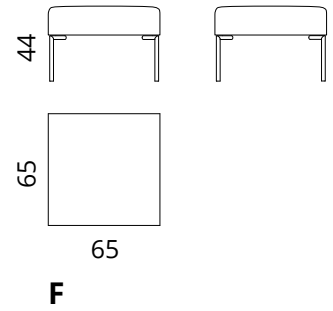
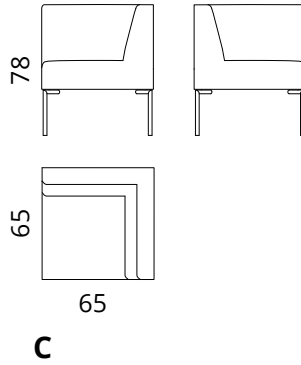
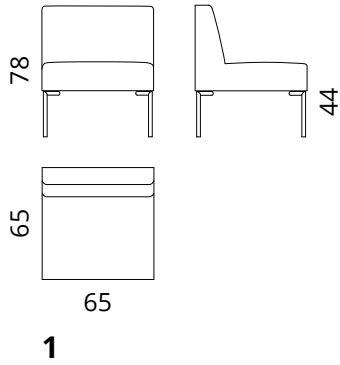

## Armrest modules

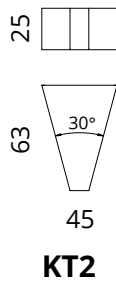
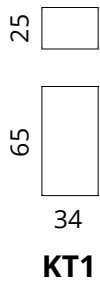

## Tables

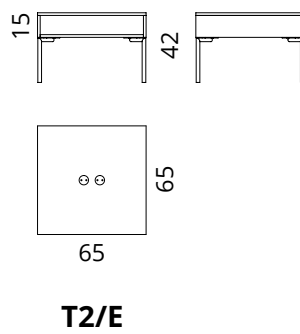
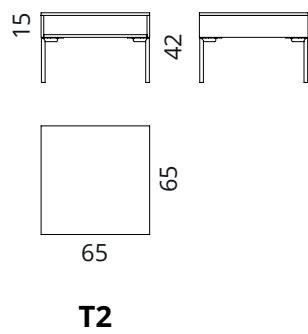
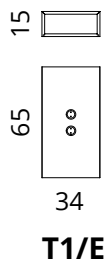
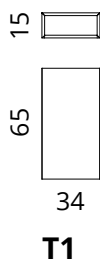

All dimensions provided in centimetres.

Seat depth: 48 cm

# Example combinations

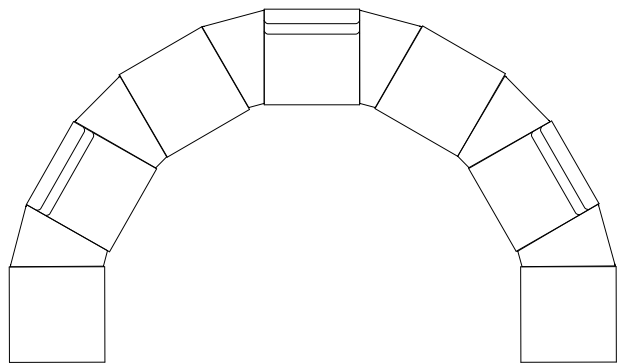
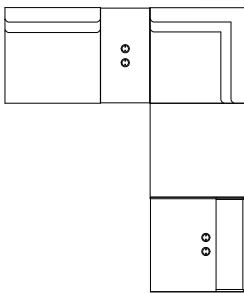
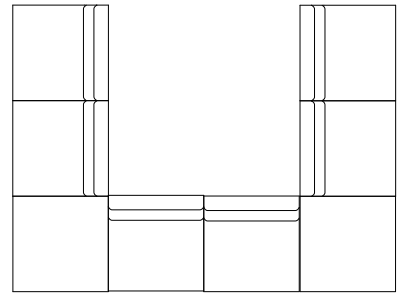
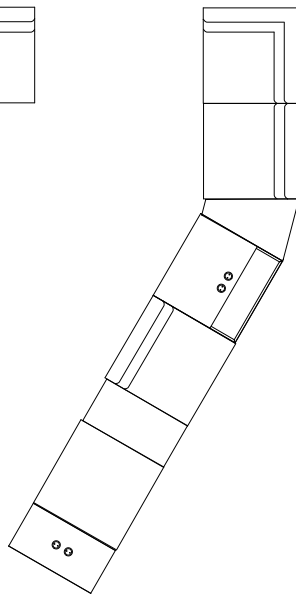
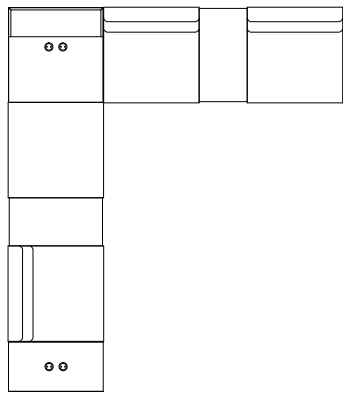
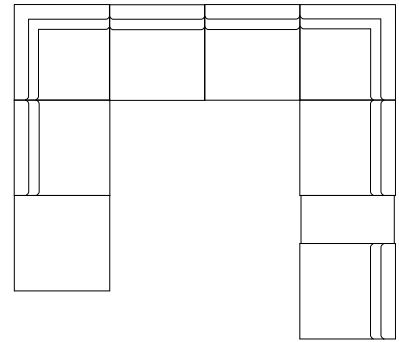
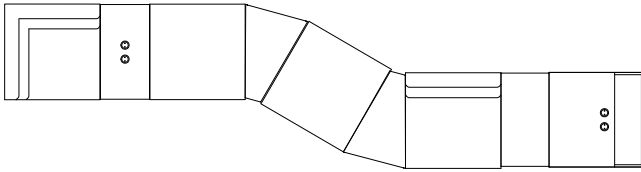
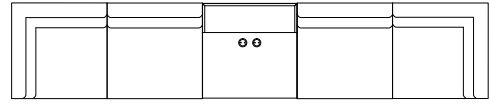
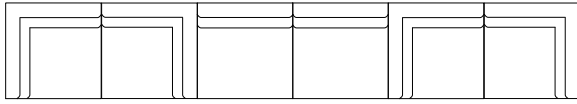

# Sans

A soft work sofa



This product has been created for:

- › Public areas
- › Private meetings
- › Dividing space into different zones
- › Resting or relaxation



Design: Argo Tamm

Designed as a sofa for use in public spaces, Sans is more than just comfortable – it's so cozy you'll probably never want to get up again! The soft upholstery is offset by a slender metallic base. It's the perfect place to get some work done or gather your thoughts uninterrupted, while the power sockets and USB port keep you connected to the rest of the world. A range of back pillows, modules and tables enables you to turn Sans into exactly the piece of furniture you need for your work and activities – whether that be a private corner with high walls, a little island in the middle of an open space or one of numerous other options.



## Product information

### Frame

Solid wood and plywood

### Seat & backrest

Durable and fireproof HR-foam; innovative Dymetrol material

### Additional pillows

Feather filling; two sizes available



### Plug-in option

### Legs

Powder-coated metal, colour option: black; plastic soles

### Additional information

The cover fabric is not removable; wide range of cover materials, including flame- retardant textiles

### Accessories

Various additional tables; material: Forbo Furniture Linoleum, colour option: black







# Example combinations

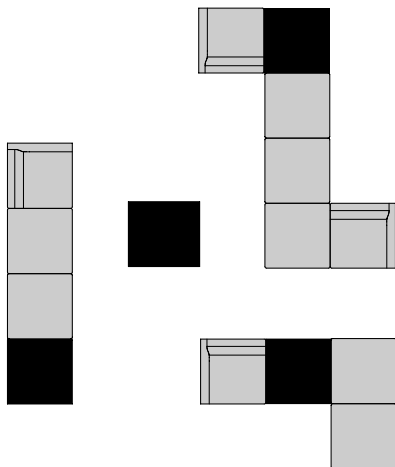
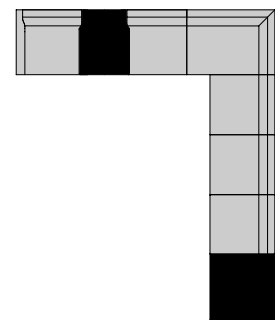
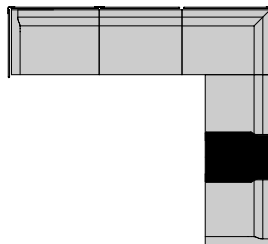
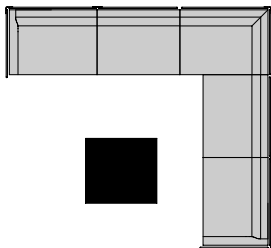
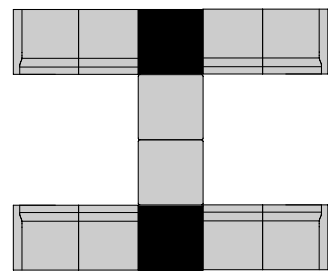
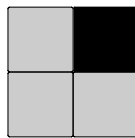
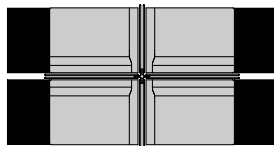
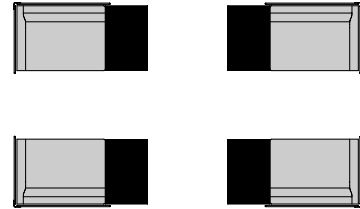
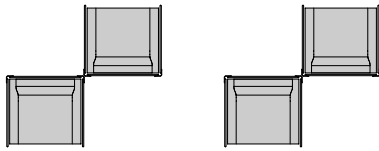



# Dimensions

Individual modules

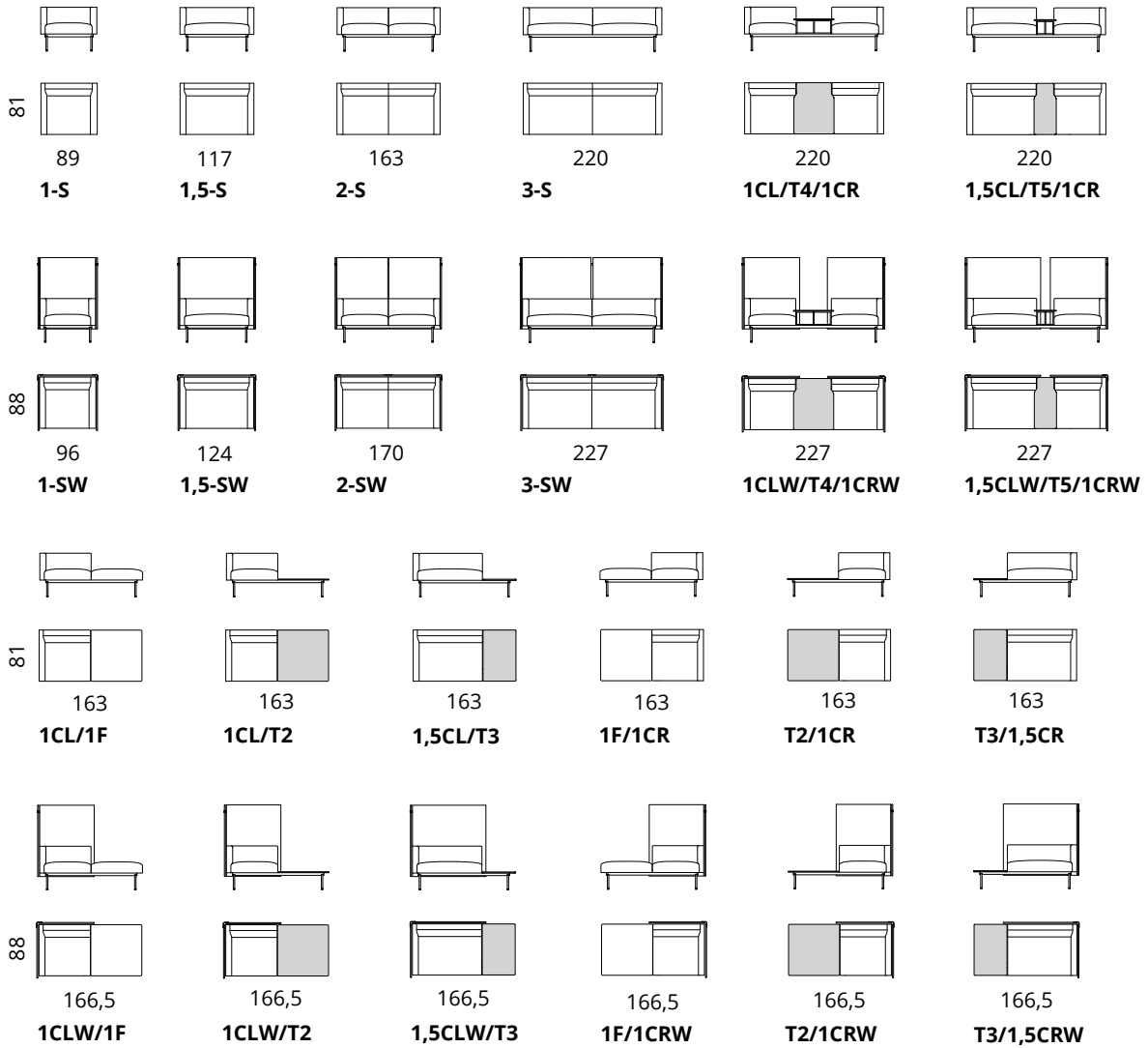
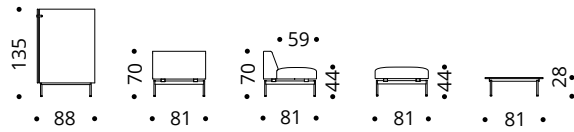

New

Poufs and tables

Additional pillows

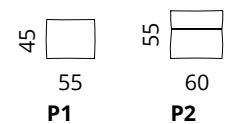
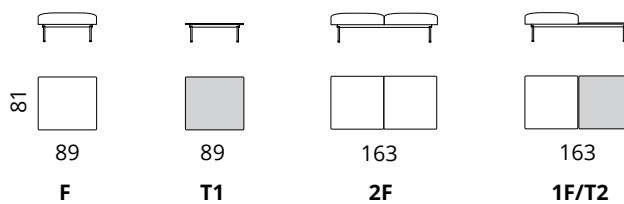
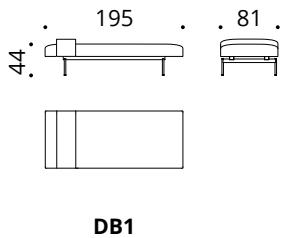

All dimensions provided in centimetres.

# Dimensions

Modules to combine

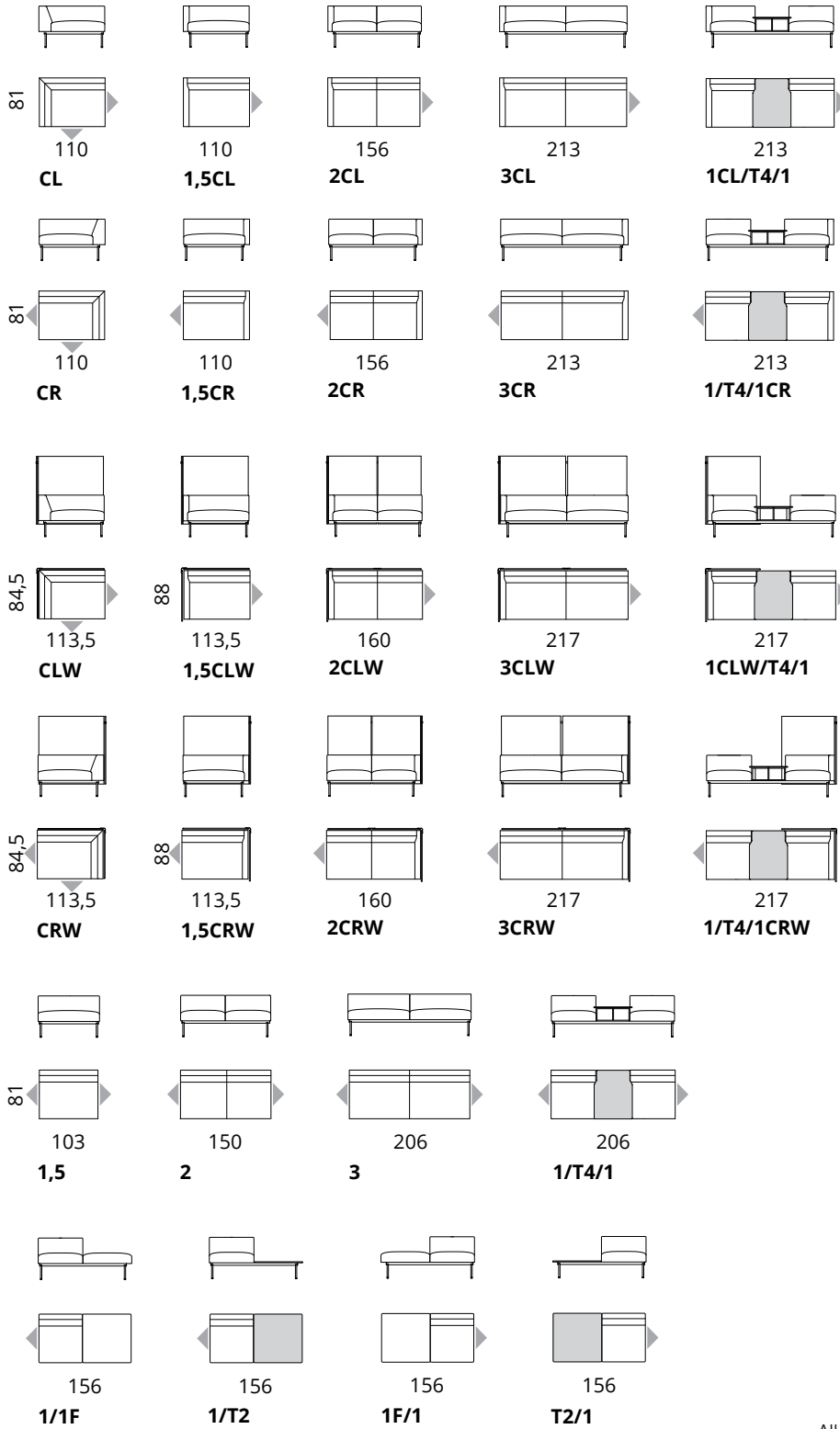

All dimensions provided in centimetres.

# Sigmund

Sound-absorbing screen



This product has been created for:

- › Dividing space into different zones
- › Dampening noise
- › Creating separated corners
- › Use as an information board



**Design:** Pent Talvet  
Iseasi

A modern office is a flowing environment that shifts and changes along with its workers and the work they do. This sound-absorbing screen enables you to easily create zones in an office. **Using more than one module, you can establish a noise-dampening wall** or a little corner for people to sit together in. This type of a screen is irreplaceable in spaces where the nature of the work you're doing demands more privacy than a fully open room allows.

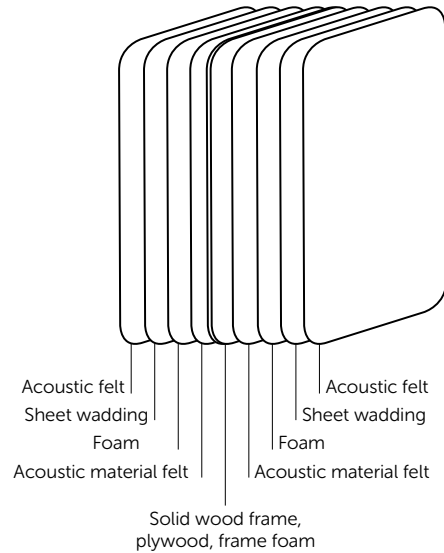

## Dimensions

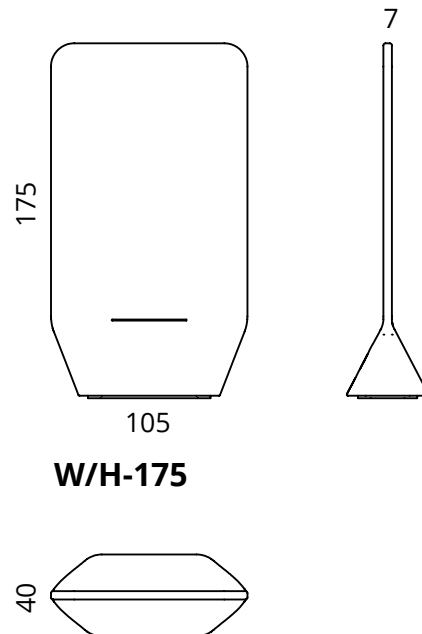

All dimensions provided in centimetres.

## Product information

### Frame

Solid wood and plywood

### Filling

Synthetic felt with sound-absorbing qualities; cotton batting; HR-foam

### Legs

360° rotating wheels

### Additional information

The cover fabric is not removable; wide range of cover materials, including flame-retardant textiles

# Sofi

Sofa & pouf system



This product has been created for:

- > Small offices
- > Waiting areas
- > Use in larger offices (several at a time)



**Design: Janno Nõu**  
Iseasi

The Sofi series was designed to make people in offices feel more at home. In terms of style it's more fun than your average office furniture, and more slimline and approachable, too. The use of legs (rather than a base) produces a lightness that's both literal and figurative, and invites people to rearrange the poufs around the room to suit themselves. The Sofi series is well-suited to smaller offices, as well as to larger office spaces in greater numbers.



## Product information

### Frame

Solid wood and plywood

### Seat & backrest

Durable and fireproof HR-foam

### Legs

Solid wood oak

### Additional information

The cover fabric is not removable; recommended cover fabric: felt



# Dimensions

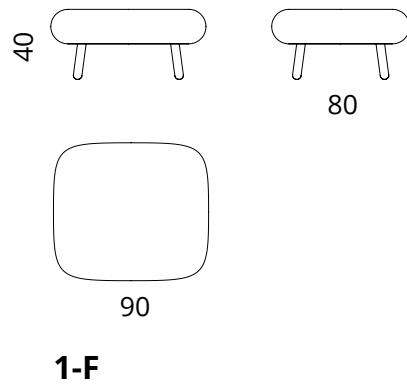
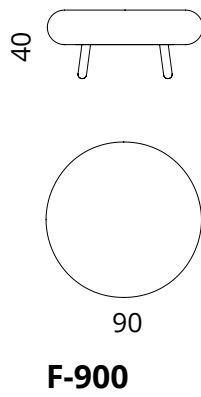
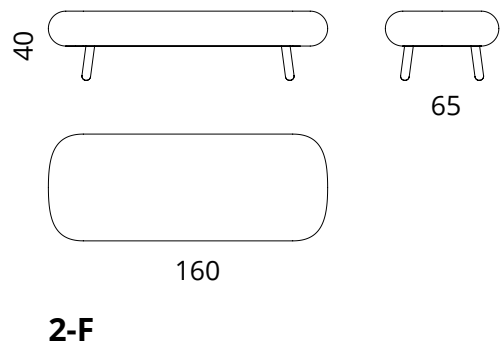
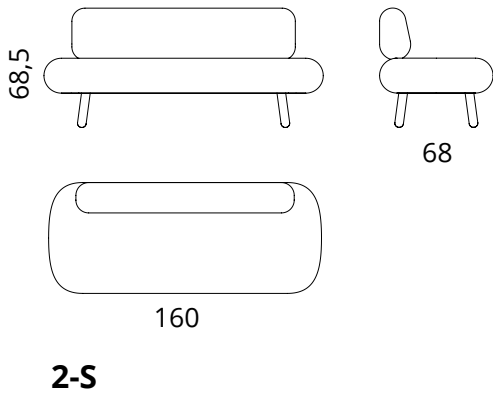

Seat depth: 48 cm

All dimensions provided in centimetres.



# Cover materials

## Valchromat® colour options for additional table

Applicable: August, Frankie, Meeter

Valchromat® is an innovative wooden board that combines the natural properties of wood with bright colours. Because Valchromat is about 30% more dense than usual MDF boards and is coloured throughout, it is also more resistant to mechanical damage.

In the Valchromat production process, painted wood particles are glued together with a special low-formaldehyde resin with good lubricity. Small wood particles create a delicate sparkling pattern on the board, so differences in colour and pattern may sometimes occur.

### Standard Colors



Light grey

Grey

Black

- Custom color at customer's request from Valchromat colour catalogue
- Additional optional cost will be added
- Custom colour is not stock material, extra delivery time 2-3 weeks



### Non Toxic

Ecological organic dyes.  
Formaldehyde emissions are within the limits set by European standards.

## Standard colour options for metal frame

Applicable: August, Frankie, Meeter, Penta, Museo, Sans



White  
RAL 9016

Grey  
RAL 7030

Graphite  
RAL 7022

Black  
RAL 9005

- Custom colour choice at customer's request from RAL catalogue
- Custom colour is not stock material, it is necessary to specify the minimum quantity, extra delivery time 2-3 weeks



Yellow  
RAL 1032

Red  
RAL 3016

Purple  
RAL 4007

Blue  
RAL 5009

## Solid wood finishing options for legs and leg frames

Applicable: August, Lilja, Sofi, Rolf, Meeter



Whitened

Natural

Dark

Wenge

Black

## High-pressure Laminate

Applicable: August, Frankie, Meeter, Penta, Museo, Sans, Rolf

### Standard Colors



White  
Formica Infiniti™  
F949 White

Gray  
Abet Polaris 2907  
Gris Foncé Pol

Black  
Abet Polaris 2902  
Noir Pol

Bio-Oak  
F7603

Custom colour is not stock material, it is necessary to specify the minimum quantity, extra delivery time 2-3 weeks

**Formica Infiniti™** – Matte, fingerprint-resistant, high-pressure laminate.

As beautiful as it is durable, Formica Infiniti® Laminate features a soft-to-the-touch super matte finish, resists fingerprints, has thermal healing capabilities and built-in antimicrobial surface protection.

**Abet Polaris** is smooth and velvety to the touch, and its surface features are truly extraordinary: it is highly resistant to scratches and heat, as well as being anti-fingerprint. The curious combination of durability and velvet smoothness gives Polaris a futuristic appeal, making it the ideal choice for ultra contemporary projects, delighting the senses with a pleasant and unique effect.

# Fabric collection



Our standard selection includes contract fabrics from different suppliers:

- Camira
- Kvadrat
- Gabriel
- Nevotex
- Agua

## Sustainable fabrics

Caring about the world around us we make long-lasting furniture and use fabric leftovers on specially designed products. To minimize our impact on nature even further we have also included several environmental-friendly and recycled fabrics to our standard selection.

**Camira's Rivet** is designed to blend the aesthetic qualities of luxury woolen apparel with modern performance sportswear, Rivet is a lightly textured

hopsack which emulates the swathe of suiting in a well-heeled synthetic. Rivet is made from 100% REPREVE®, a brand of recycled polyester made from used plastic bottles.

**Gabriel's Cura** is a multi-purpose, two-coloured upholstery fabric made from 98% post-consumer recycled polyester. It fuses modern performance with a warm, casual aesthetics and a soft, voluminous touch.

## Plug-in options



### Plug-in options under the surface



#### BACHMANN POWER STRIPS

Electric outlet: 3x220W+ 2xUSB

UK, CH, IT, UTE (France), DK, EU

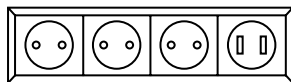

#### POWERDOT Mini 51 mm

Electric outlet: 220W + 2xUSB

EU

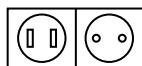



## Integrated Plug-in options



### BERKER INTEGRO FLOW

Integrated electric outlet: 220W + 2xUSB

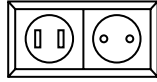

#### Socket outlet with earthing contact

USA/Canada NEMA 5-15 R, USA/Canada NEMA 6-20 R, Australia 10 A, AUSTRALIA 15 A, Denmark, EU, Italy, Switzerland type 13, Switzerland type 23, British standard, Netherlands, Euro-American standard

#### Socket outlet with earthing pin

### BERKER INTEGRO FLOW HDMI (Applicable: August Workbay)

High definition socket outlet with HDMI™ double jack type A, supports HDMI™ technology (V 1.3 with Deep Color)



### POWERDOT Mini 51 mm

Electric outlet: 220W + 2xUSB

EU

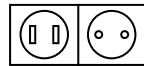

### POWERDOT 79 mm

Integrated electric outlet: 220W + 2xUSB

EU, DK, UK, FR, CH

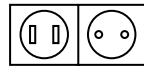

## Good to know

All polyurethane foams used in our products meet the requirements of ignition class SL-1 (difficult to ignite).

All colors and polishes meet ISO standards.

We only use FSC certified wood.



PE FURNITEST has carried out an assessment on August, Frankie, Meeter, Hexa, Penta, Sans sofa collection in accordance with standard EN 16139:2013 including correction EN 16139:2013/AC:2013 level of test severity L1 requirements.



Follow us

 @softrend\_global

 Softrend

 softrend.ee

